

# Series 2700 Fabric Door Canopy

It is our recommendation that you read instructions carefully prior to assembly and installation.

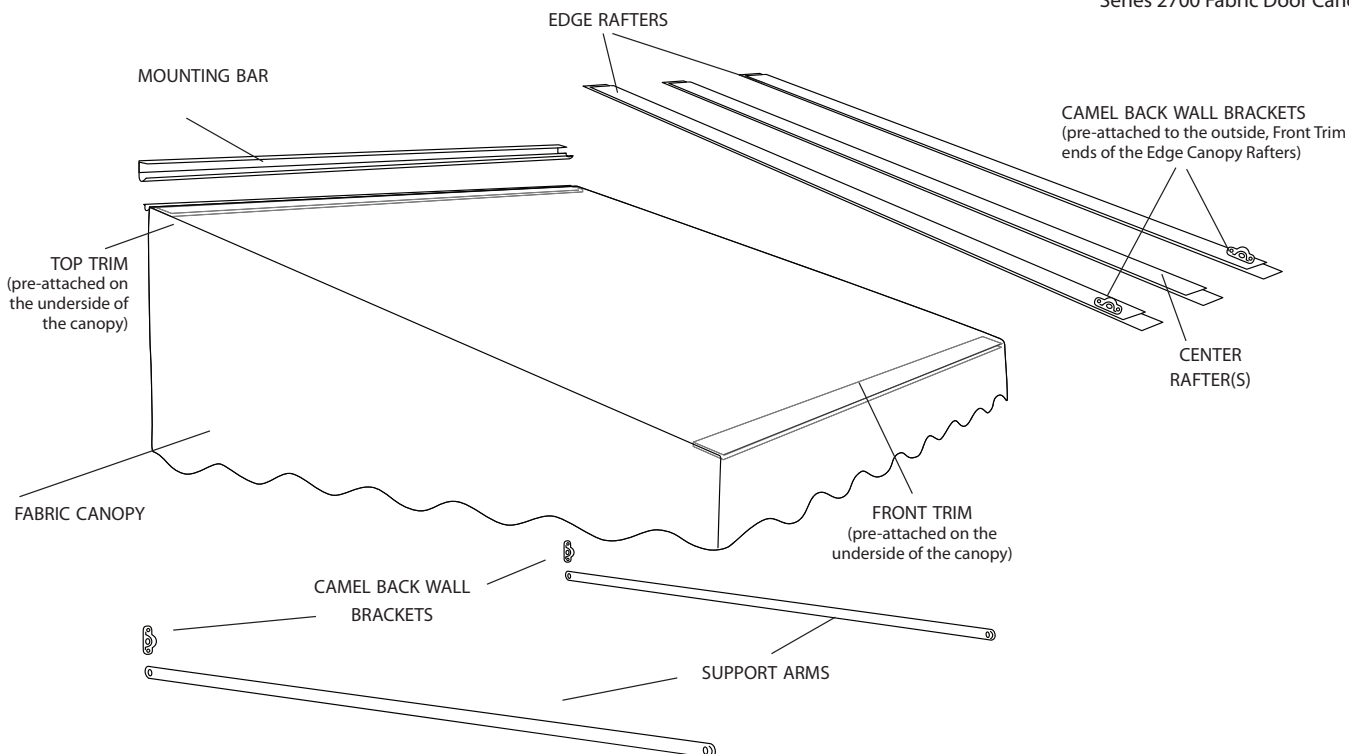

Series 2700 Fabric Door Canopy



### Series 2700 Parts Check List:

- |                                                |                                           |                                                           |                                        |
|------------------------------------------------|-------------------------------------------|-----------------------------------------------------------|----------------------------------------|
| <input type="checkbox"/> Fabric Canopy         | <input type="checkbox"/> Edge Rafters (2) | <input type="checkbox"/> Support Arms*                    | <input type="checkbox"/> Small Screws* |
| <input type="checkbox"/> Top Trim (attached)   | <input type="checkbox"/> Center Rafter(s) | <input type="checkbox"/> Camel Back Wall Brackets*        | <input type="checkbox"/> Large Screws* |
| <input type="checkbox"/> Front Trim (attached) | <input type="checkbox"/> Mounting Bar     | <input type="checkbox"/> Machine Screws (its tip is flat) |                                        |

\*QUANTITIES & SIZE OF PARTS MAY VARY BY AWNING SIZE AND MODEL SERIES

### Actual Size - End Views of Canopy parts for easy reference and assembly:



Mounting Bar



Top Trim



Front Trim



Edge & Center Canopy Rafter

### Required Tools:

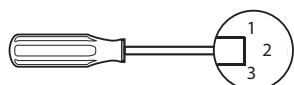

Phillips, Regular & 1/4" Hex Head  
Screwdrivers or Drill Bits

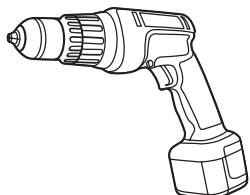

Power Drill

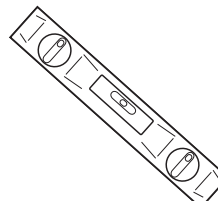

Level

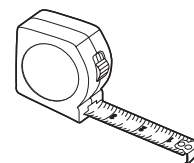

Tape Measure

# Assembly Instructions

## Series 2700 Fabric Door Canopy

1



The Series 2700 Fabric Door Canopy comes packaged in two separate plastic bags: Bag one contains the hardware and instructions; bag two contains the canopy with three frame pieces, a Mounting Bar, Top Trim and Front Trim. For your convenience, the Front Trim and Top Trim frame parts are already attached to the canopy.

2

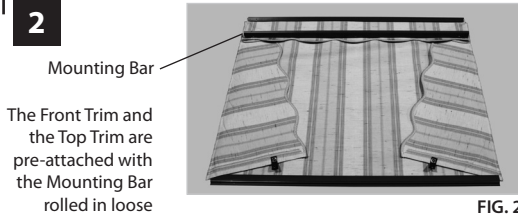

The canopy will come rolled with the top or outside rolled to the inside. Unroll the canopy. (The Mounting Bar is rolled inside the canopy and will be used in Step 1 of this manual's *Installation Instructions*. Set it aside for now.) Open the sides and flip the whole canopy over. The canopy will be assembled from this position, **upside (or topside) down** and **inside (or underside) up**. The Top Trim and Front Trim frame pieces are already attached.

3

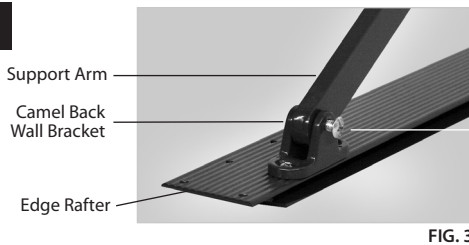

To begin, attach one end of one of the Support Arms to the Edge Rafter by inserting it into the Camel Back Wall Bracket that is already mounted on the Edge Rafter using a machine screw.

*NOTE: Insert the machine screws through the Camel Back Wall Bracket and the Support Arms **from the outside in**, toward the canopy.*

4

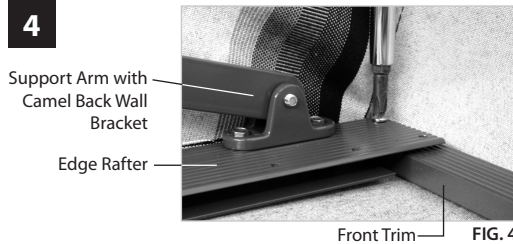

Attach one Edge Rafter to the Front Trim using small screws in pre-punched holes; the Front Trim is behind the valance on the inside of the canopy and is pre-attached.

*NOTE: Be sure to position the Edge Rafters so that the ends with the attached Camel Back Wall Bracket/Support Arm are toward the outside and at the front of the canopy (Front Trim).*

5

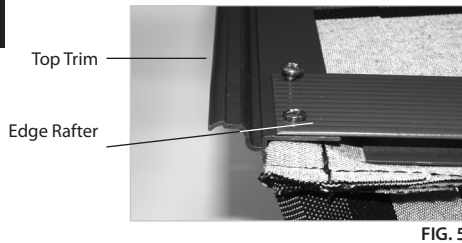

Attach the other end of the Edge Rafter to the Top Trim on both sides using two small screws in pre-punched holes.

Repeat Steps 3, 4 and 5 for the second Support Arm and secure the other Edge Rafter on the other side of the canopy.

6

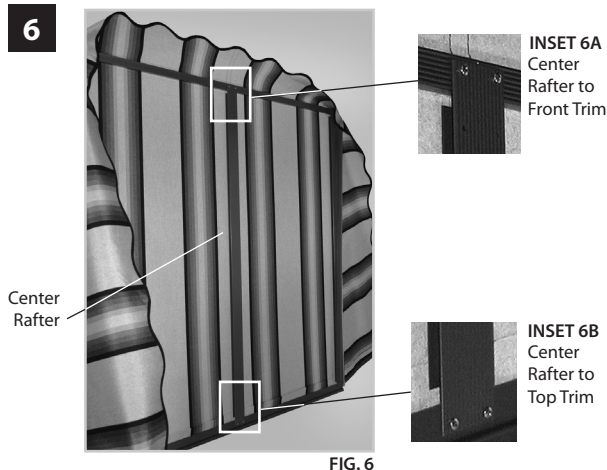

Position the Center Rafter(s) and align with pre-punched holes at the Front Trim and the Top Trim. Then, fasten the Center Rafter to the Front Trim first and then the Top Trim with two small screws at each end (FIG. 6).

Your canopy is now ready for installation.

*(INSETS 6A & 6B) The Fabric Canopy is turned vertically to show placement of Center Rafter with attachment details to the Front Trim and Top Trim.*



SERIES 2700  
Door Canopy

# Installation Instructions

1

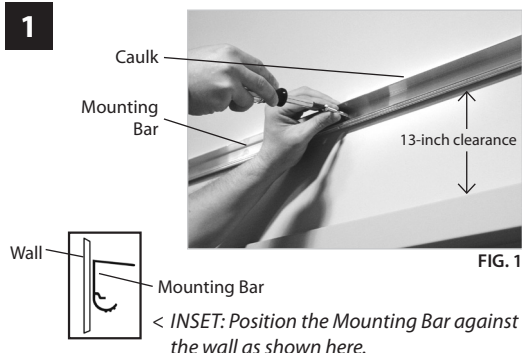

Install Mounting Bar with large screws 13" above the door.

Be sure the bar is level and centered over the door opening. Screws must be in studs or heavy sheathing. (Drill alternate holes in bar if necessary.) Please refer to FIG. 1 INSET to place the Mounting Bar correctly on the wall.

**!** Caulk the top of the Mounting Bar against the house.

2

Lift the front of the canopy upward and insert the Top Trim into the Mounting Bar (FIG. 2A). Lower front of canopy slowly and allow Sides and Support Arms to rest on the house (FIG. 2B); be sure the two parts are completely interlocked. Align holes and secure Top Trim to Mounting Bar with small screws from bottom side (FIG. 2C).

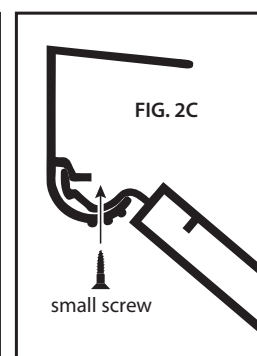
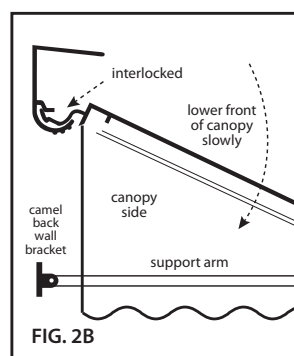
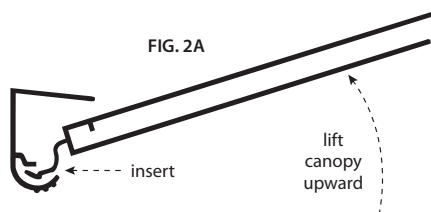

3

## (Front) - Canopy Frame Views - (Side)

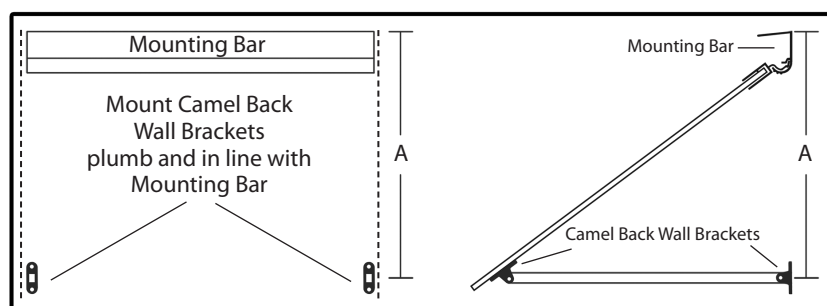

Temporarily attach the two loose Camel Back Wall Brackets to the other end of the Support Arms using machine screws.

Before securing Support Arms with Camel Back Wall Brackets to your house, please refer to the mounting chart to the left for model number and correct mounting points for your canopy.

*NOTE: Mounting dimension 'A' is measured from the top of the Mounting Bar to the center of the Camel Back Wall Brackets (see chart).*

Now, attach mounting brackets to the house using large screws, making sure the Camel Back Wall Brackets are secured in solid sheathing at the proper points from the reference chart.

### Door Canopy Mounting Chart

Model Number	4	5	6	7	8
Mounting Point	7-1/2"	9"	10-1/2"	12"	13-1/2"

4



After Camel Back Wall Brackets have been secured to the house, remove the machine screws and re-insert them through grommeted tabs on your canopy to secure the canopy sides, and screw them back into the Camel Back Wall Brackets.

Installation of your Series 2700 Fabric Door Canopy is now complete.

# Thank you for ordering the Series 2700 Fabric Door Canopy

Nulmage Awnings® has a full line of fabric awnings to complement your selection. Contact your local home improvement retailer, or visit [www.nulmageawnings.com](http://www.nulmageawnings.com) today to learn more about these other quality products made in the USA.

## Series 3700



Fabric Window Awning with Sides

## Series 4700



Fabric Casement Window Awning with Sides

## Series 5700



Fabric Roll-up Window Awning

## NUShade



Retractable Patio Awning

### Limited Warranty information

Nulmage® Awnings and Canopies are manufactured by Futureguard® under the highest standards of production, after comprehensive research and development, and will be warranted by Futureguard® to the original purchaser from date of purchase for a period of Five (5) years against the occurrence of manufacturing defects directly resulting in peeling, flaking, blistering or rusting under conditions of normal use and service, subject to the terms and conditions contained in this Limited Warranty.

Futureguard® does not warrant installation nor defects caused by installation. This Limited Warranty does not cover any other defects as specified herein. This Limited Warranty does not cover any other damage or material failure resulting from, but not limited to, normal weathering, oxidation, accidental damage or intentional damage, fire or flood, windblown objects, windstorm, sleet or chemical pollutants, mildew or structural defects, negligent maintenance or misuse or abuse, or any other causes or occurrences beyond the control of Futureguard®. Under this warranty Futureguard agrees to provide material, repair, refinish, or replace at their sole option, only the parts found to be defective at no cost to the original owner. This warranty does not include any shipping or labor required to complete the warranty work.

Normal weathering may cause any surface to oxidize, chalk, gradually fade or accumulate surface dirt or stains due to varying exposures to sunlight, weather or atmospheric conditions. The geographic location, the quality of the atmosphere and other local factors in the area, over which Futureguard® has no control, contribute to the severity of these conditions.

This Limited Warranty is void if incompatible accessory products are installed which cause defects to occur.

The provisions of this Limited Warranty are the full and complete warranty policy extended by Futureguard®.

This Limited Warranty shall be null and void if harmful cleaning compounds are used.

THE WARRANTY STATEMENTS CONTAINED IN THIS LIMITED WARRANTY SET FORTH THE ONLY EXPRESS WARRANTIES EXTENDED BY FUTUREGUARD®, IN LIEU OF ALL OTHER WARRANTIES, AND THE PROVISIONS OF THIS LIMITED WARRANTY SHALL CONSTITUTE THE ENTIRE LIABILITY OF FUTUREGUARD® AND THE PROPERTY OWNER'S EXCLUSIVE REMEDY FOR BREACH OF THIS WARRANTY FUTUREGUARD® SHALL NOT BE LIABLE TO THE PROPERTY OWNER FOR INCIDENTAL OR CONSEQUENTIAL DAMAGES OF ANY KIND FOR BREACH OF ANY EXPRESS OR IMPLIED WARRANTY.

Claim procedure and other warranty provisions. All claims for warranty must be reported in writing to Futureguard, 101 Merrow Road, Auburn, Maine 04210 Attention: Warranty Dept., within the warranty period and promptly after discovery. Describe the defect in detail and include photos, if possible together with proof of purchase. The effective warranty date shall not be increased by any such warranty work performed and the remaining warranty time shall continue in effect.

Some states do not allow the exclusion or limitation of incidental or consequential damages, so the above limitations or exclusions may not apply to you. This Warranty gives you the specific legal rights and you may also have other rights, which vary from state to state.



[www.nulmageawnings.com](http://www.nulmageawnings.com)

Customer Service 1-800-901-3313



FGNI.2700.Rev12/16